

Maxxi Tent

Gestaltungsraster, 1,5 x 1,5 m Dachflächen

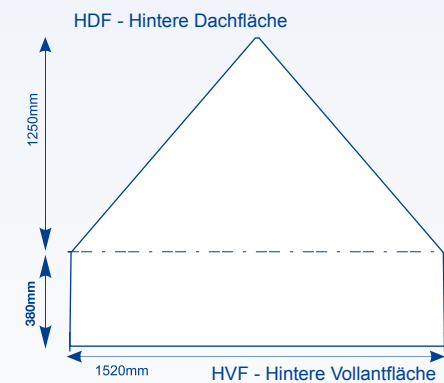

GROSSBILDLÖSUNGEN

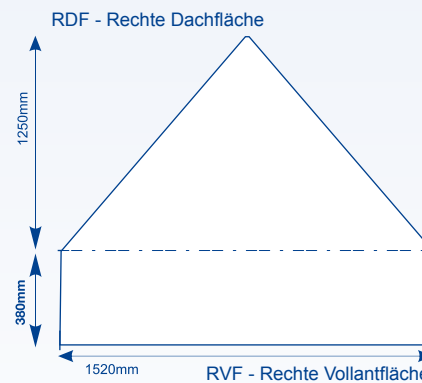
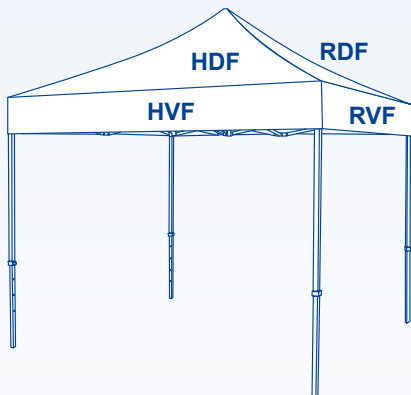
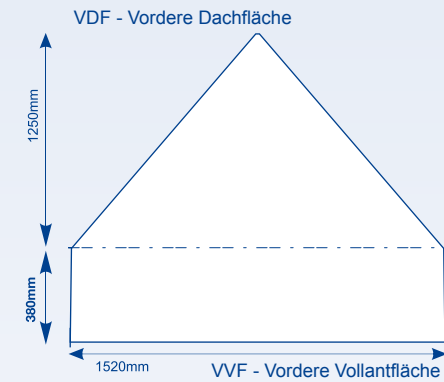
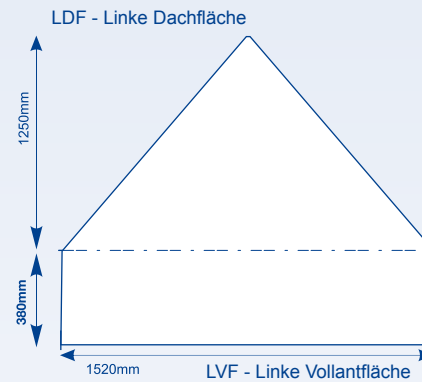
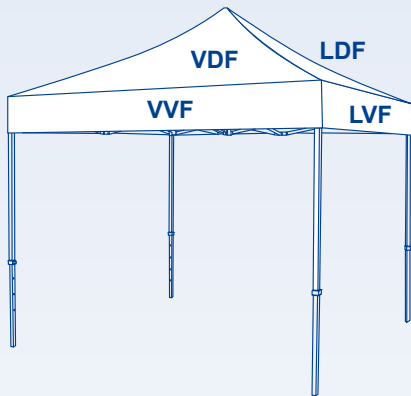

Legende

- Flächenkante
- Nahtlinie
- Dach/Vaulant Trennungslinie



www.displayhersteller.de

Maxxi Tent

Gestaltungsraster, 1,5 x 1,5 m Wand-Innenflächen



GROSSBILDLÖSUNGEN

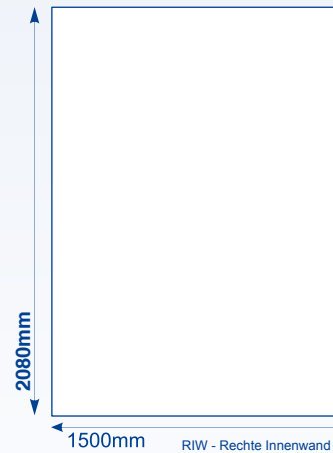
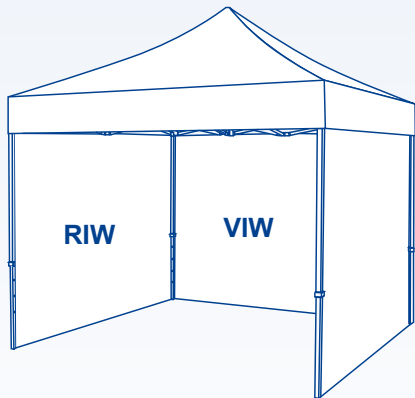
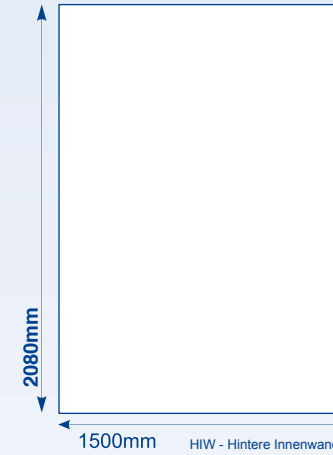
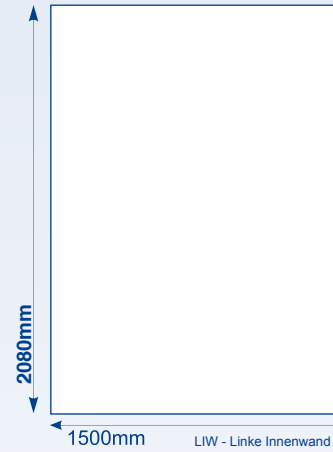
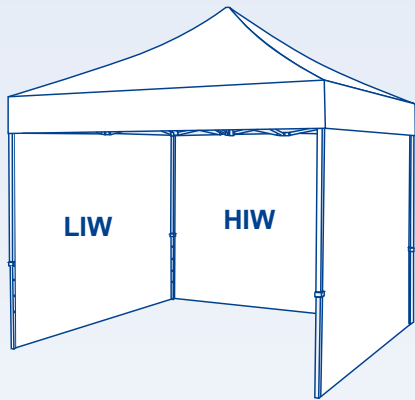

Legende

— Flächenkante - - - - Nahtlinie - · - · - Dach/Vaulant Trennungslinie

[display] hersteller

www.displayhersteller.de

Maxxi Tent

Gestaltungsraster, 1,5 x 1,5 m Wand-Außenflächen



GROSSBILDLÖSUNGEN

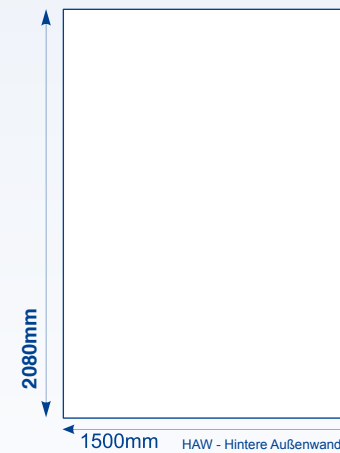
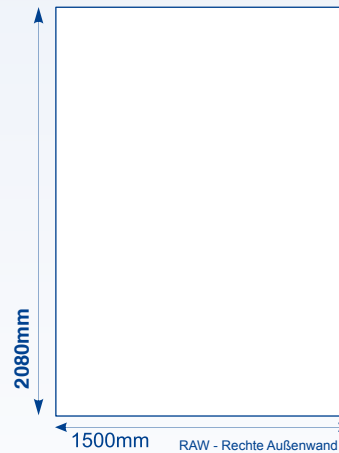
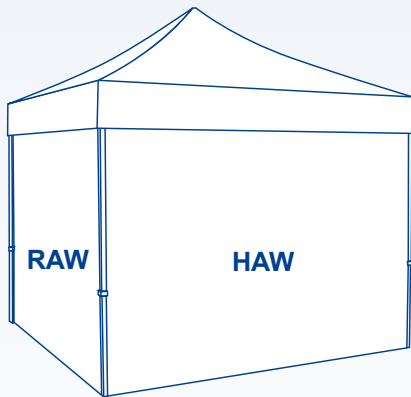
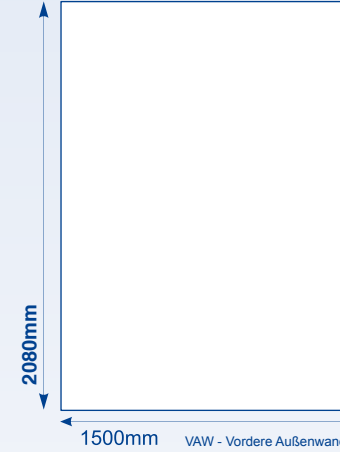
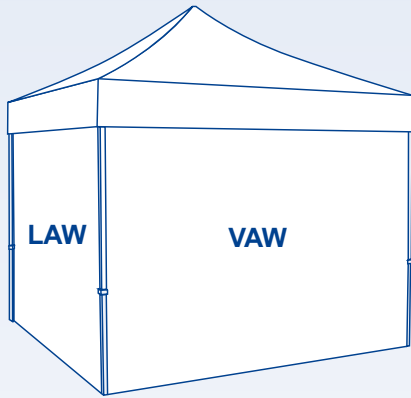

Legende

— Flächenkante

- - - Nahtlinie

- · - · - Dach/Vaulant Trennungslinie

[display] hersteller

www.displayhersteller.de

Maxxi Tent

Gestaltungsraster, 1,5 x 1,5 m Innere Wandhälften



GROSSBILDLÖSUNGEN

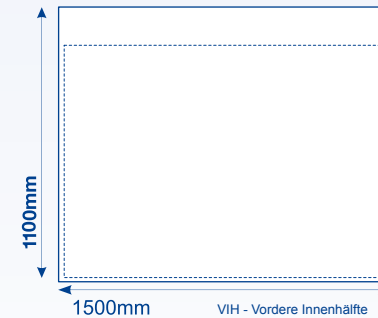
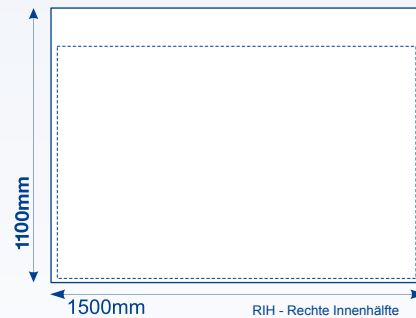
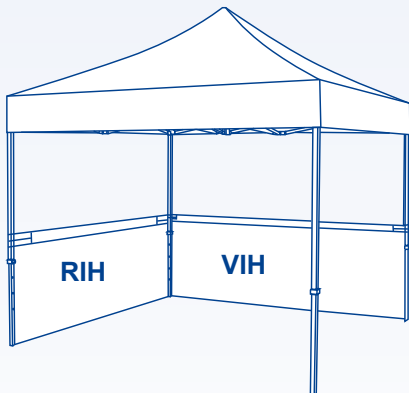
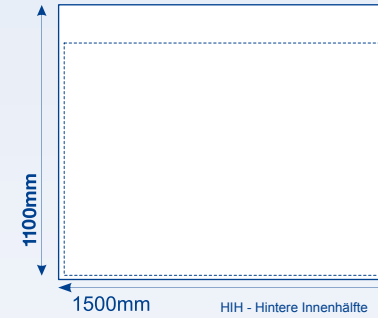
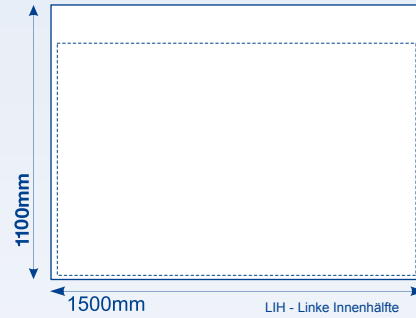
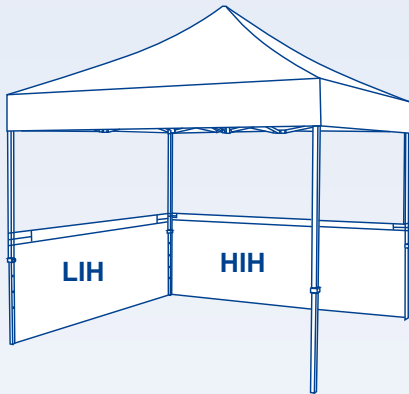

Legende

— Flächenkante

- - - Nahtlinie

- · - Oberes Ende der Wandhälfte

[display] hersteller

www.displayhersteller.de

Maxxi Tent

Gestaltungsraster, 1,5 x 1,5 m Äußere Wandhälften



GROSSBILDLÖSUNGEN

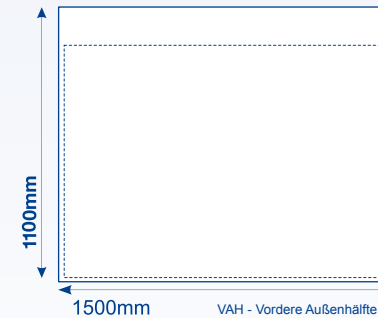
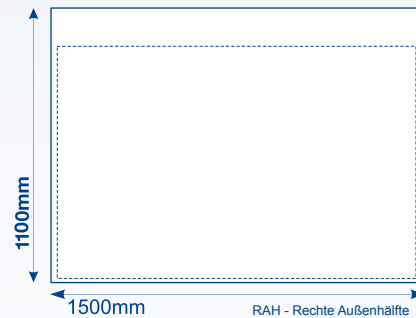
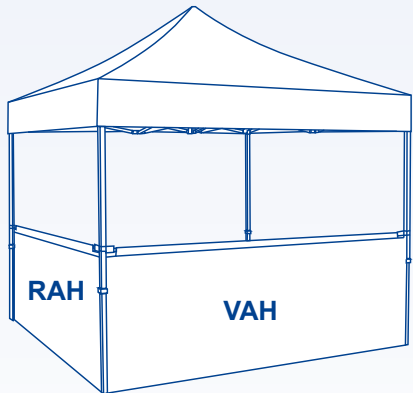
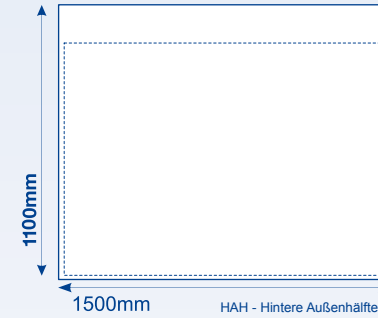
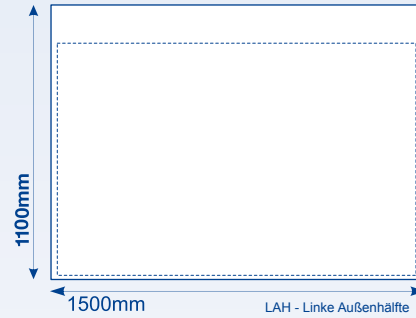
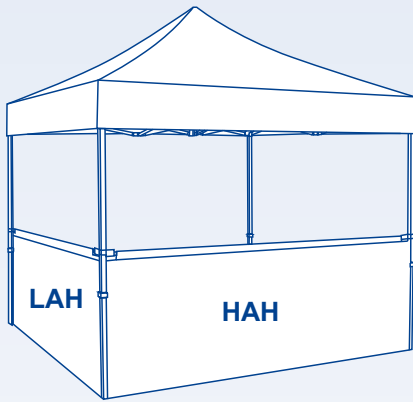

Legende

— Flächenkante

- - - Nahtlinie

- · - · Oberes Ende der Wandhälfte

[display] hersteller

www.displayhersteller.de