

# Maxxi Tent

Gestaltungsraster, 3 x 3 m Dachflächen

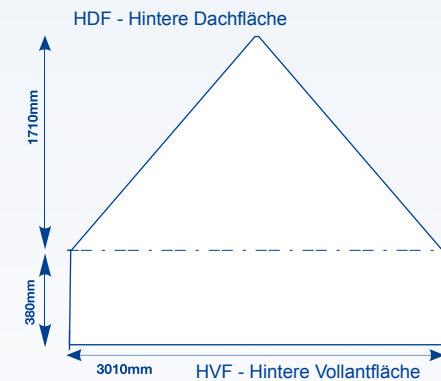

GROSSBILDLÖSUNGEN

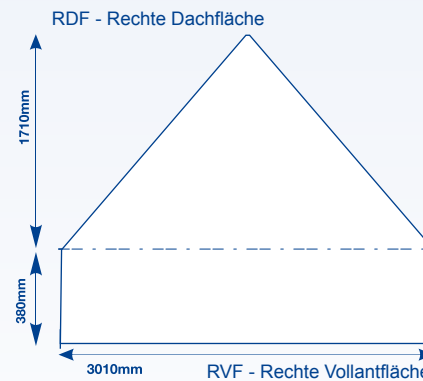
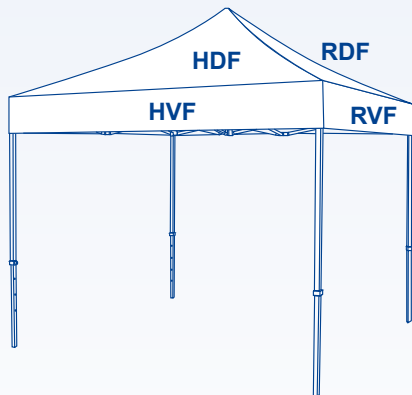
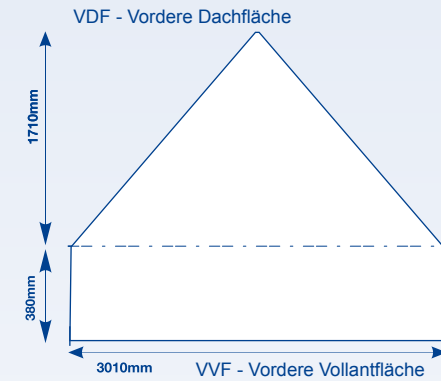
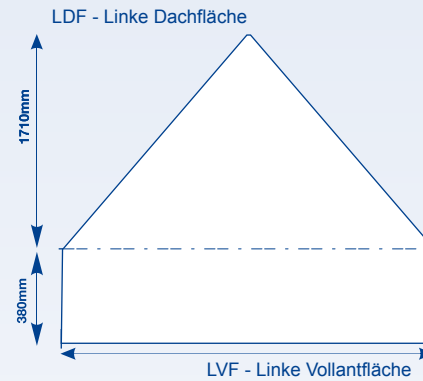
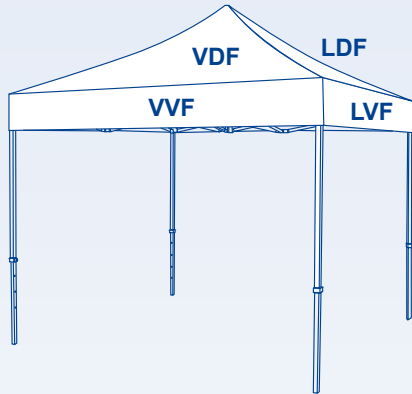

## Legende

— Flächenkante

--- Nahtlinie

- - - Dach/Vaulant Trennungslinie

[display] hersteller

www.displayhersteller.de

# Maxxi Tent

Gestaltungsraster, 3 x 3 m Wand-Innenflächen



GROSSBILDLÖSUNGEN

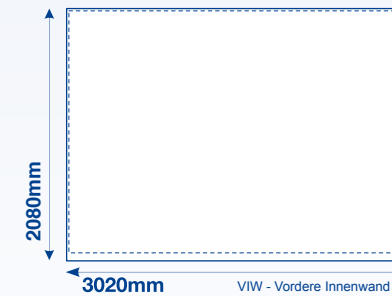
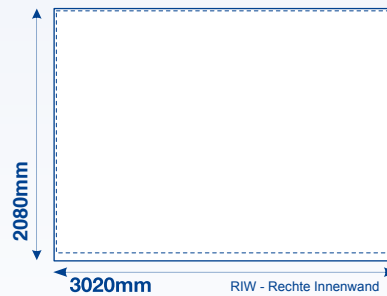
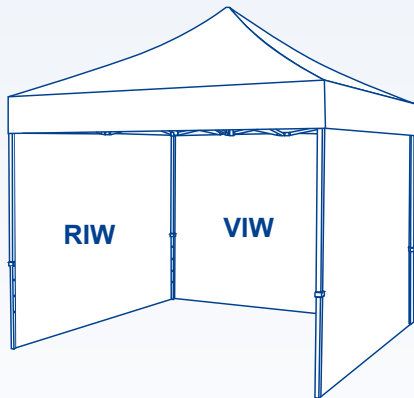
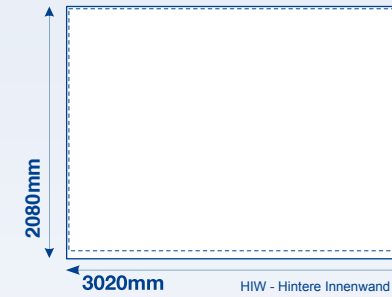
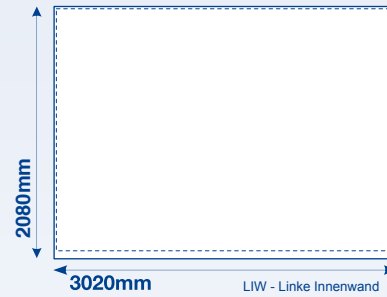
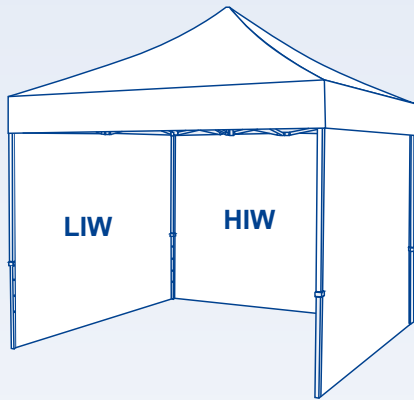

## Legende

— Flächenkante    - - - - Nahtlinie

[display]hersteller

www.displayhersteller.de

# Maxxi Tent

Gestaltungsraster, 3 x 3 m Wand-Außenflächen



GROSSBILDLÖSUNGEN

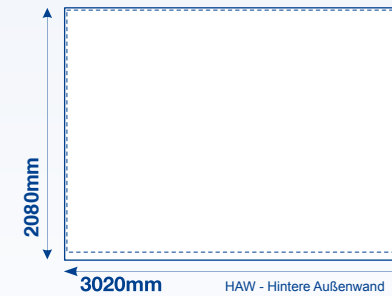
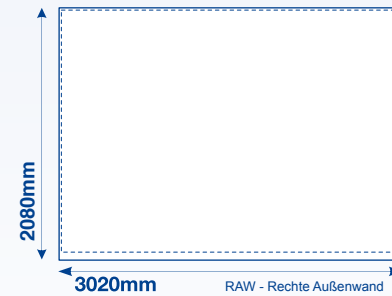
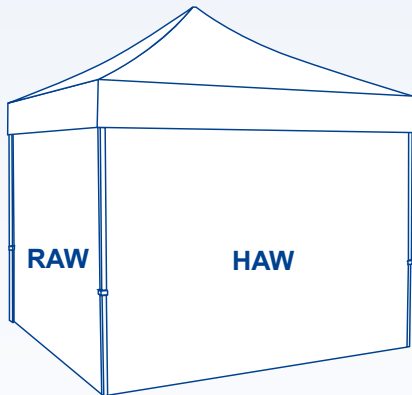
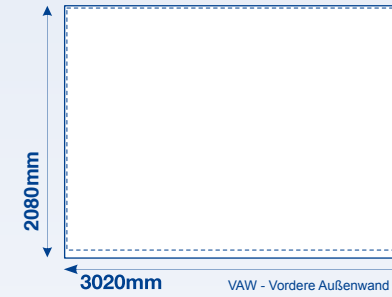
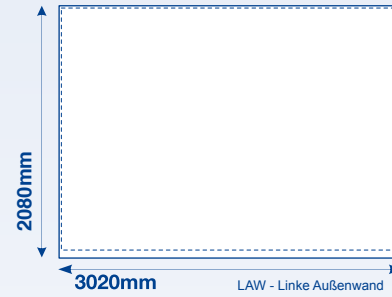
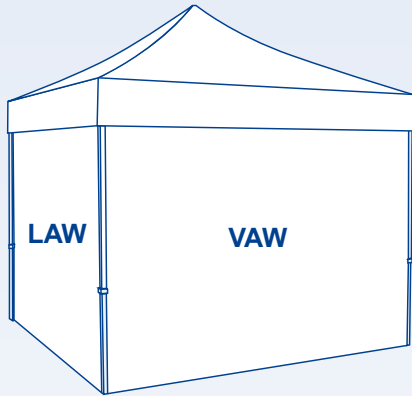

## Legende

— Flächenkante

- - - Nahtlinie

[display]hersteller

www.displayhersteller.de

# Maxxi Tent

Gestaltungsraster, 3 x 3 m Wand-Außenflächen mit Fenster

**m a x x i**  
**p r i n t**

GROSSBILDLÖSUNGEN

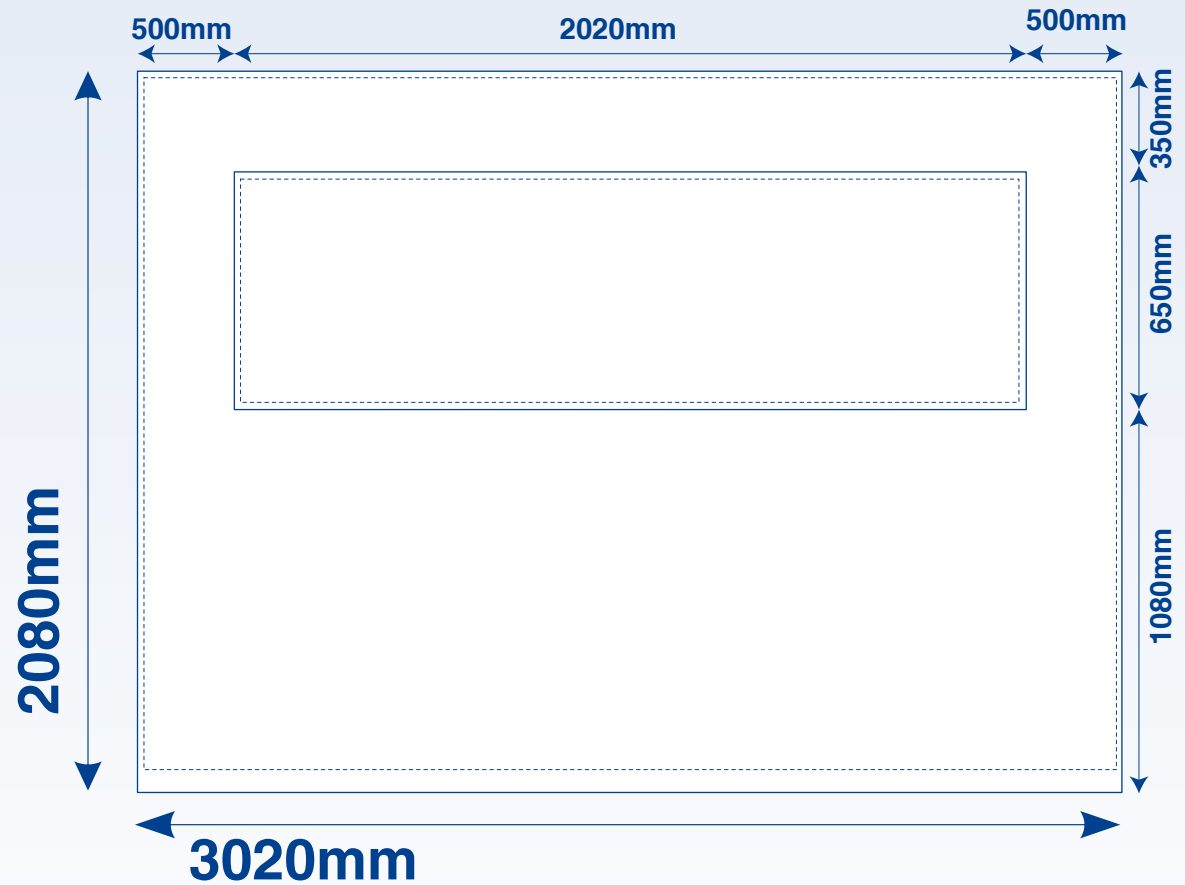
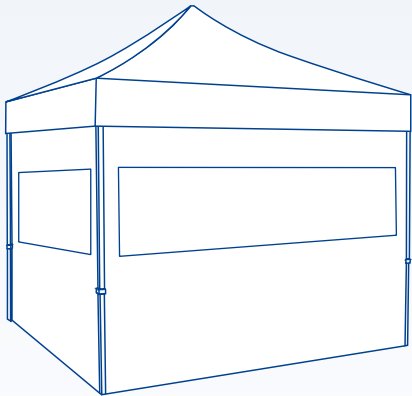
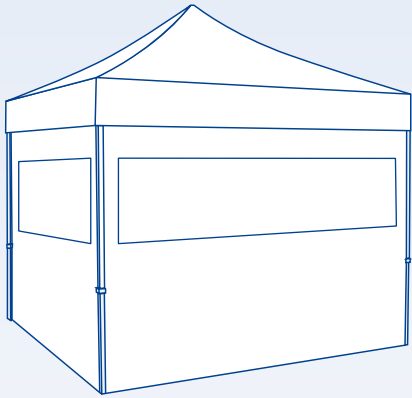

## Legende

— Flächenkante

- - - Nahtlinie

**[display]hersteller**

[www.displayhersteller.de](http://www.displayhersteller.de)

# Maxxi Tent

Gestaltungsraster, 3 x 3 m Innere Wandhälften

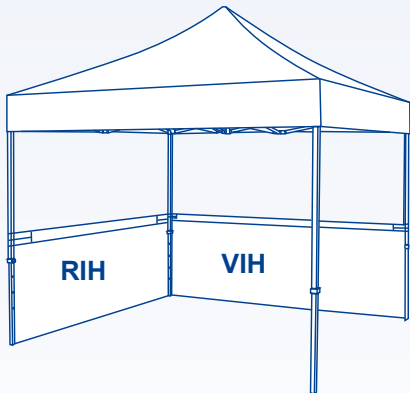
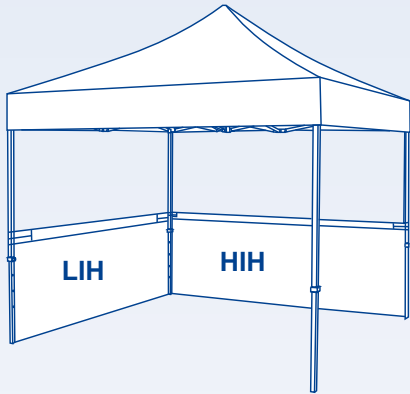

## Legende

— Flächenkante    - - - - Nahtlinie    · · · · · Oberes Ende der Wandhälfte

# Maxxi Tent

Gestaltungsraster, 3 x 3 m Äußere Wandhälften

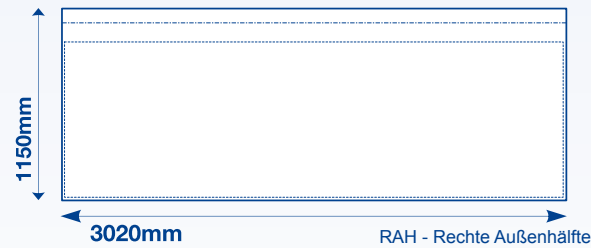
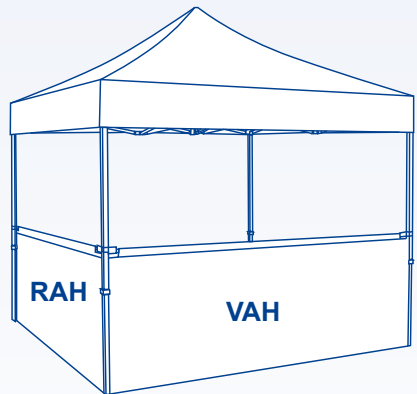
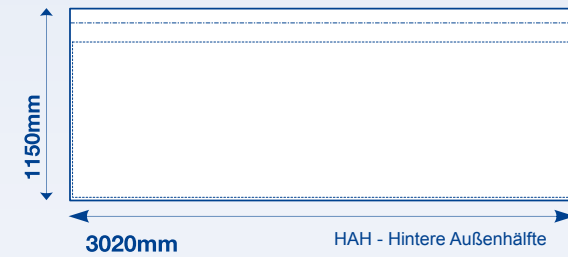
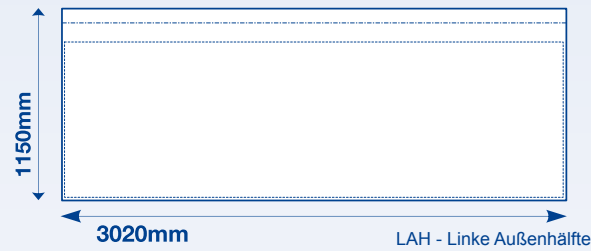
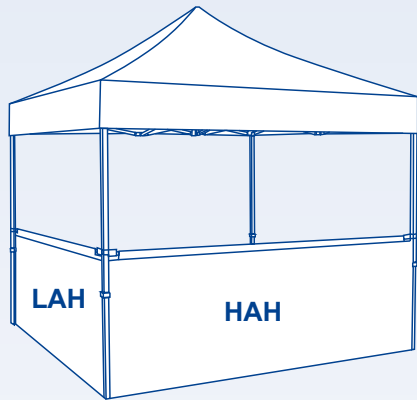

## Legende

— Flächenkante    - - - - Nahtlinie    - · - - Oberes Ende der Wandhälfte